



ARCHITECTURAL
GRATES + DRAINS



SDiAR

Slot Drain

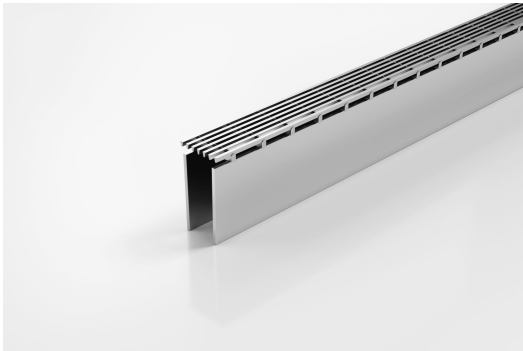

This is a Wedgewire Stainless Steel Grate component to fit the Slot Drain SD90 - Please note SD90 Slot Drain is sold separately

The latest addition to the original SlotDrain, we now have the narrowest stainless steel grate to add style to the Slotdrain.

Please be aware that depending on the installation environment, for a pool installation or close to a surf beach, you may need to have your stainless steel grates electropolished.

Code SDiAR
Range Slot Drain
Grate Style AR
Category Components
Steel Grade 316

SPECIFICATIONS + DIMENSIONS

Channel Width	30mm
Channel Depth	Adjustable
Length(s)	1000mm 1500mm
Outlet Size	N/A

STORMTECH COLOUR FINISHES

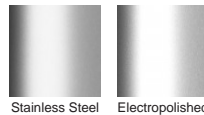

Electroplate finishes subject to natural variation with time and local environment. Factors such as pools/surf beaches may require electropolishing. Contact us for suitability.

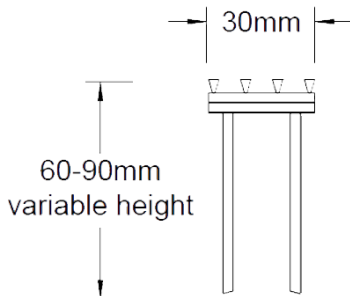

Grates longer than 1500mm supplied in sections. Tile Inserts longer than 1200mm supplied in sections. Channels over 3000mm supplied in sections with joiner. +/-2mm tolerance on dimensions.

PRODUCT APPLICATIONS

- Balcony Drainage
- Commercial Drainage
- Courtyard / Patio Drainage
- Driveway Drainage
- Pool and Spa Area Drainage
- Paved Area Drainage
- Special Needs Drainage

Copyright © Stormtech Pty Ltd. Patent 733361. Drawings not to scale, please use dimensions shown. Downloaded 03/06/2026 (please check for updates)



Visit stormtech.com.au
for tools + inspiration.

Phone **1300 653 403**

Email info@stormtech.com.au