



ARCHITECTURAL
GRATES + DRAINS



38ARG40

Linear Drain

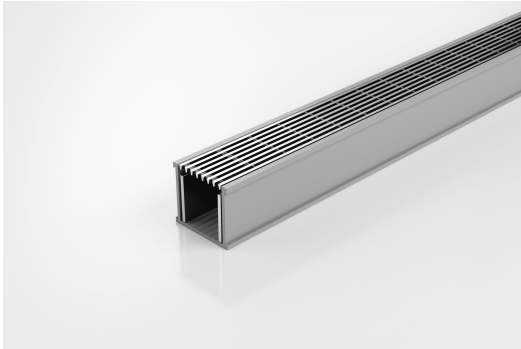

Modular drainage kit with stainless steel grate(s), a uPVC drainage channel and fittings.

The 38ARG40 is a premium architectural style grate featuring a 2mm wire/2.5mm gap.

The grate(s) are manufactured from 316 marine grade stainless steel and the channel and fittings from uPVC.

Lengths over 3000mm available on request.

Refer to AS3500 for outlet pipe sizes specific to your installation.

Code 38ARG40

Range 38

Grate Style AR

Category Modular Kits

Channel Material uPVC

Steel Grade 316

SPECIFICATIONS + DIMENSIONS

Channel Width	46mm
Channel Depth	42mm
Length(s)	1200mm 1500mm 2400mm 2700mm
	3000mm
Outlet Size	DN40, DN50

STORMTECH COLOUR FINISHES

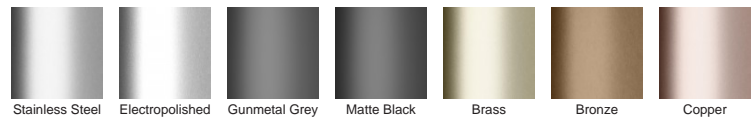

Electroplate finishes subject to natural variation with time and local environment. Factors such as pools/surf beaches may require electropolishing. Contact us for suitability.

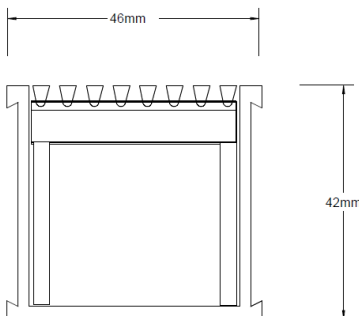

Grates longer than 1500mm supplied in sections. Tile Inserts longer than 1200mm supplied in sections. Channels over 3000mm supplied in sections with joiner. +/-2mm tolerance on dimensions.

PRODUCT APPLICATIONS

- | | |
|-----------------------------|----------------------------|
| Bathroom Drainage | Hospitality Drainage |
| Aged / Health Care Drainage | Paved Area Drainage |
| Balcony Drainage | Shower Drainage |
| Commercial Drainage | Multi-Residential Drainage |
| Courtyard / Patio Drainage | Special Needs Drainage |
| Pool and Spa Area Drainage | Threshold Drainage |

Copyright © Stormtech Pty Ltd. Patent 733361. Drawings not to scale, please use dimensions shown. Downloaded 02/06/2026 (please check for updates)



Visit **stormtech.com.au**
for tools + inspiration.

Phone **1300 653 403**

Email **info@stormtech.com.au**