



ARCHITECTURAL  
GRATES + DRAINS



# SD90H

## Slot Drain



### 90mm Drain with UPVC Beige Insert

The SD90 features a 25mm opening on the top with 20 slots draining into a concealed 90mm drain pipe with UPVC beige insert.

The PVC insert comes with 10mm holes at 50mm centres .

The Slot Drain can be completed with a 30mm wide architectural wedge-wire grate as an optional item.

**Code** SD90H

**Range** Slot Drain

**Category** Modular Kits

**Channel Material** uPVC

### SPECIFICATIONS + DIMENSIONS

<b>Channel Width</b>	25mm
<b>Channel Depth</b>	Adjustable
<b>Length(s)</b>	3030mm
<b>Outlet Size</b>	N/A

### PRODUCT APPLICATIONS

Commercial Drainage  
Courtyard / Patio Drainage  
Driveway Drainage  
Pool and Spa Area Drainage  
Paved Area Drainage

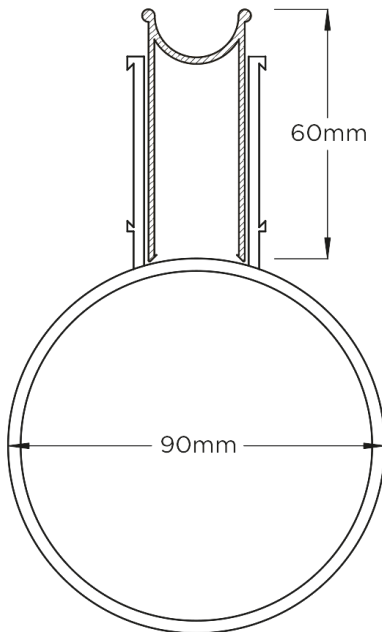

Grates longer than 1500mm supplied in sections. Tile Inserts longer than 1200mm supplied in sections. Channels over 3000mm supplied in sections with joiner. +/-2mm tolerance on dimensions.

Copyright © Stormtech Pty Ltd. Patent 733361. Drawings not to scale, please use dimensions shown.  
Downloaded 02/06/2026 (please check for updates)



Visit [stormtech.com.au](https://stormtech.com.au)  
for tools + inspiration.

Phone **1300 653 403**

Email [info@stormtech.com.au](mailto:info@stormtech.com.au)